

Roller Shade

3" and 4" Fascia Installation Instructions



WARNING

STRANGULATION HAZARD — Young children can be strangled by cords. Immediately remove this product if a cord longer than 22 cm or a loop exceeding 44 cm around becomes accessible.



MISE EN GARDE

RISQUE D'ÉTRANGLEMENT — Les enfants en bas âge peuvent s'étrangler avec des cordes. Enlevez immédiatement ce produit si une corde mesurant plus de 22 cm devient accessible ou si le contour d'une boucle de plus de 44 cm devient accessible.

NOTE: Fabric wrapped valances must be handled with care

1

PREPARATION

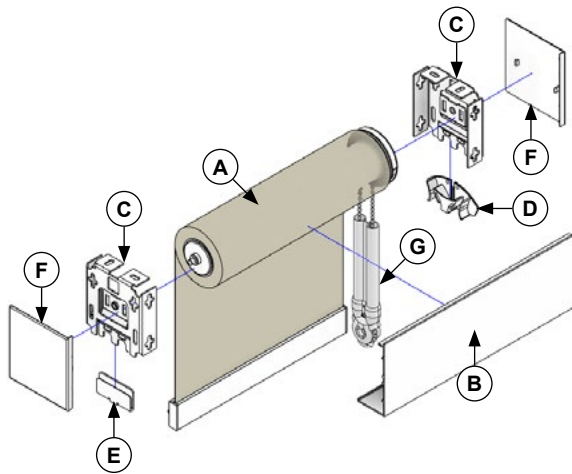

Component List

- A. Shade
- B. Fascia
- C. Mounting Bracket
- D. Chain Diverter
- E. Chain Diverter Placeholder
- F. Bracket Cover (Optional)
- G. Safety Shield

2

MOUNT THE BRACKETS

Brackets must be installed to ensure a 1/8" gap is left on each side for end caps.

CEILING MOUNT

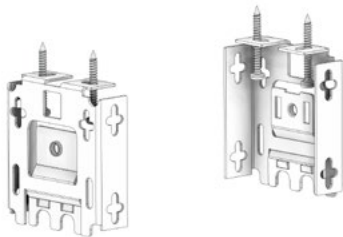

WALL MOUNT

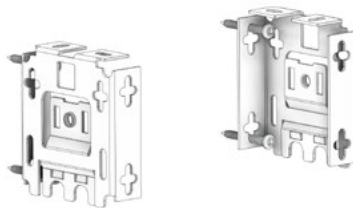

LATERAL MOUNT

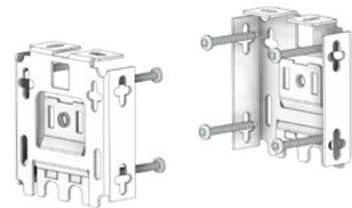

Screw in back - Cut end caps leaving enough distance from the back to the screws.

3 INSTALL THE SHADE

NOTE: For shades with Zero Gravity, please refer to Zero Gravity instructions on page 3 at this stage.

STEP 3A: INSTALL PIN END FIRST

Put the spring loaded Pin End into the hole in the bracket.

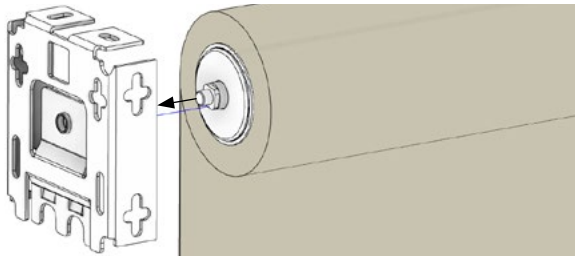

STEP 2C: INSTALL CLUTCH END

Keeping gentle pressure against the Pin End lift the clutch end up and align the two hooks on the clutch with the two slots in the bracket. The hooks should fall into place in the bracket, pull down gently to secure the blind into the bracket.

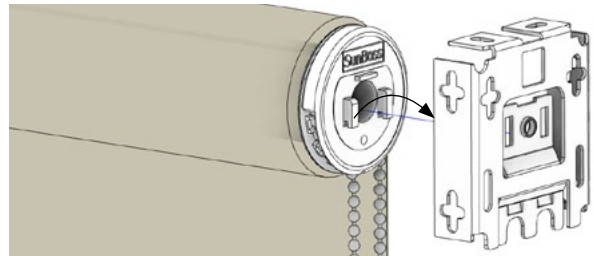

4 INSTALL THE CHAIN DIVERTER

Insert the front chain into the outside channel on the chain diverter, then insert the rear chain into the rear inside channel. Then insert the chain diverter into the mounting bracket until you here an audible click. Also insert the placeholder tab into the mounting bracket on the idle end.

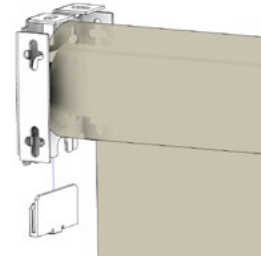
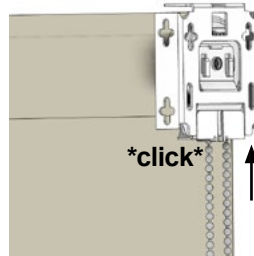
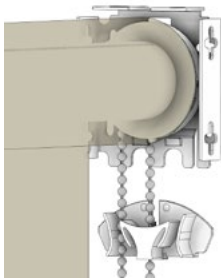

5 INSTALL THE FASCIA

NOTE: For inside mount shades: snap the bracket covers on before hooking to the mounting brackets

- (1) Hook the fascia on the top corner of the mounting brackets,
- (2) then swing the bottom in. (3) You should hear a distinct click.
- (4) For outside mount shades, install the bracket covers by snapping them on to the fascia mounting brackets.

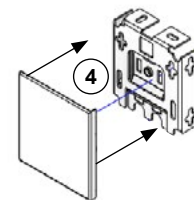
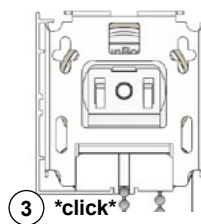
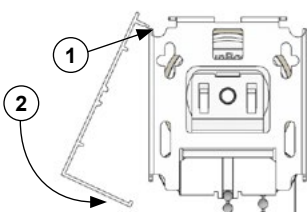

6 INSTALL THE SAFETY SHIELD

NOTE: For shades with chain operation only.
Ensure that Safety Shield is carefully and properly installed.

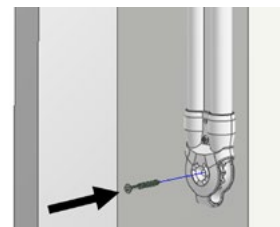



Zero Gravity - Fascia or Open Roll Instructions

These steps are not required for Zero Gravity in Curved Cassettes.
Skip these steps if using chain, Neo, or motorized control

If the Pin End of the shade appears as shown here, proceed with **Steps 1,2 & 3** before returning to **Step 4** of the **Open Roll Installation Instructions**



If the Pin End of the shade appears as shown here, proceed with **Steps 4,5 & 6** before returning to **Step 4** of the **Open Roll Installation Instructions**



1 PREPARING FOR INSTALLATION

NOTE: The blue shipping lock is used to lock the tension in place during shipping.

Hex Plunger
Remove shipping lock before installing

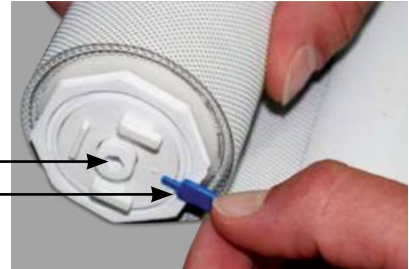

2 INSTALLING THE SYSTEM

(A) Insert the pin end of the blind into the bracket.

(B) Insert the hooked end into the other side bracket, and ensure the Zero Gravity head sits on the hooked teeth firmly. This should compress the hex plunger which releases the tension onto the shade.

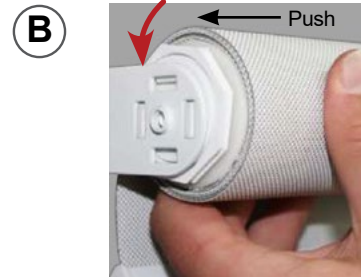
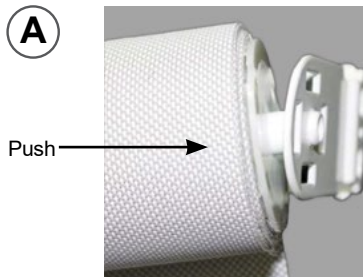

3 TESTING THE SYSTEM

Always operate the shade from the center of the bottom bar. Ensure that the shade is balanced and does not want to roll up or down on its own. If it does, then the spring will require more or less tension to be perfectly balanced. If the shade requires more tension, turn the zero gravity head into the fabric, **ie opposite direction to the fall of the fabric.**

Insert for 5mm hex
(only for outside mount)



Adjusting Spanner



Zero Gravity - Fascia or Open Roll Instructions

These steps are not required for Zero Gravity in Curved Cassettes.
Skip these steps if using chain, Neo, or motorized control

WARNING

- Do not pull pin lock out until shade is installed or tension will be released.
- If tension has been released, see trouble shooting.

1 RUBBER BAND REMOVAL

Before installing the shade remove the rubber band holding the Pin Lock in place.

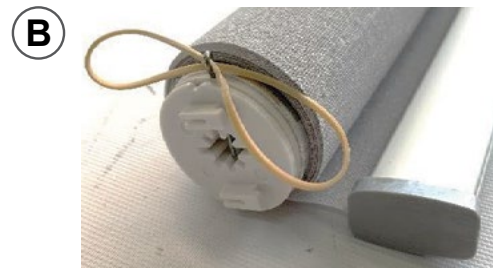

2 INSTALL SHADE AND REMOVE PIN LOCK

C: Install roller shade while keeping Pin Lock toward you and held in place.

D: After installation remove the pin lock

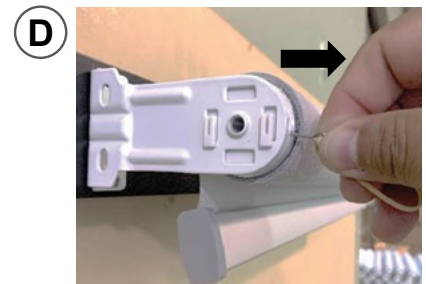
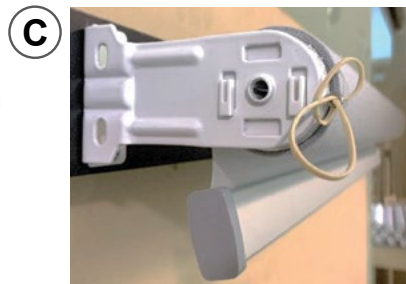

3 TESTING THE INSTALLED ROLLER SHADE

Installed roller shade must be operated smoothly by the centre of the bottom bar to avoid excessive telescoping



TROUBLE SHOOTING: ONLY REQUIRED IF TENSION IS RELEASED

If the tension is released or removed accidentally follow these instructions:
The tension can be put back in any Zero Gravity Mini by turning the clutch head in the opposite direction of the fabric approximately 1 – 2 full rotations. While holding tension, insert the Pin Lock into the hole of the clutch. **PROCEED WITH STEP 2 WHEN FINISHED.**

